

SANGIORGIO

Dryer Use and Maintenance Manual



Please read the instructions carefully
before handling, installing and using your home appliance so
as to prevent any damage to yourself and to your dryer



www.sangiorgioeletrodomestici.it
info@sangiorgioeletrodomestici.it

Table of content

| | |
|--|-----------|
| Environmental protection tips | 3 |
| Disposal of packaging..... | 3 |
| Safety and warnings..... | 4 |
| Intended use..... | 4 |
| Use by children or very vulnerable people..... | 5 |
| Definitions of children..... | 6 |
| Technical safety..... | 6 |
| Correct use..... | 7 |
| Installation | 13 |
| Transportation..... | 13 |
| Positioning..... | 13 |
| Aeration..... | 13 |
| Drainage of condensation | 14 |
| Electrical connection..... | 15 |
| Main features | 16 |
| Control panel..... | 17 |
| International drying symbols..... | 18 |
| Drying option table..... | 20 |
| Dryer functions description..... | 21 |
| Preparation of the laundry..... | 23 |
| Starting a programme..... | 24 |
| Delicate basket..... | 24 |
| Energy saving..... | 25 |
| Technical data..... | 26 |
| EC energy data 392/2012 | 27 |
| Maintenance | 28 |
| Filter cleaning..... | 28 |
| Cleaning heat exchanger inlet..... | 28 |
| Gasket and closing edge cleaning..... | 29 |
| Cleaning humidity sensors..... | 30 |
| What to do if | 31 |
| Table error and fault handling | 31 |
| After-sales assistance guidelines | 32 |
| After sales service | 33 |
| Warranty certificate | 34 |

Environmental protection tips

Disposal of packaging

Packaging has the scope of protecting the goods from any damage that may occur in transport operations. The materials used for packaging are recyclable; thus they are selected according to criteria of respecting the environment and ease of disposal aimed at reintegration into the production cycles.

Keep the original packaging and the polystyrene parts to be able to transport the appliance at a later time.

Furthermore, it is necessary to keep the packaging also for the eventual shipment to the authorized technical assistance service in case of breakdowns and/or damages.

Recycling materials allows on one hand to reduce the volume of waste while on the other it makes possible to use non-renewable resources more rationally.

Disposal of appliance

Electrical and electronic equipment often contains useful materials. They also contain substances, compounds and components that were necessary for the operation and safety of the appliance itself. Disposing of them improperly or in household waste could harm health and the environment. Under no circumstances should this appliance be disposed of in normal household waste.

Make sure that the ducts and the heat exchanger of the dryer are not damaged until they are disposed off correctly and ecologically.

This ensures that the refrigerant contained in the circuit and the compressor oil cannot disperse into the environment.

The crossed-out bin symbol indicates that the product must be given to suitable recycling centres set up by local authorities or companies or returned free of charge to the retailer when purchasing new appliance of an equivalent type, on a one-to-one basis.



The User is required to delete any personal data from the electronic appliance to be disposed. Adequate differential collection helps to avoid possible negative effects on the environment and health. It favours the recycling of the materials that makes up the appliance. For waste recovery and disposal management of household appliances, the manufacturer has adhere to the Ecodom consortium (Erion WEEE a consortium of the Erion system dedicated to the management of WEEE). Electrical and electronic appliances disposal, in pursuant of Legislative Decree 14 March 2014, n. 49 in implementation of EU Directive 2012/19 and on WEEE - Waste from Electrical and Electronic Equipment on the disposal of waste electrical and appliance equipment, make sure that the appliance is kept away from children until disposal.

How to use the dryer

PHASE 1: Start drying

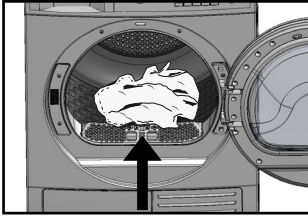

Put the laundry in the drum and close the door.

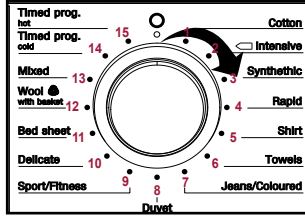

Select the programme to run.

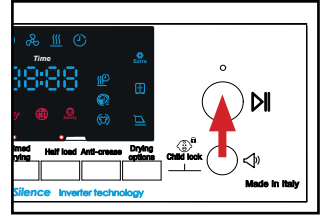

Start the programme.

PHASE 2: End of drying

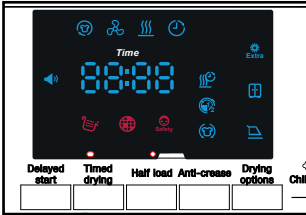

End of drying is indicated by "END".

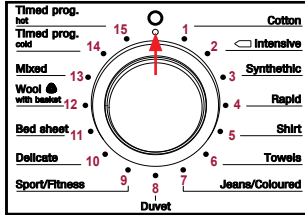

Switch off the dryer by turning the knob to "O".

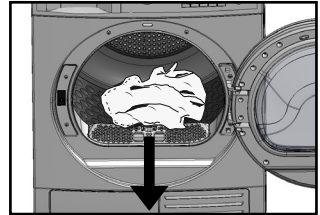

Remove the laundry.

PHASE 3: Maintenance

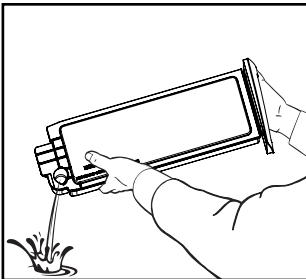

Empty the condensed water condensation container

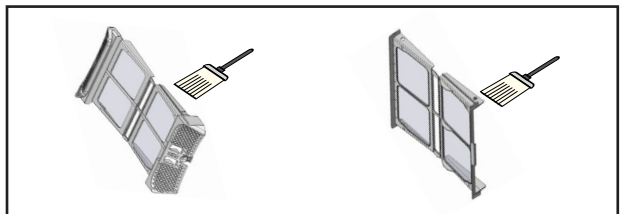

Clean the fluff filters (inside and outside)

Noise

During the drying cycle different noises could occur in different stages. These are sounds of normal product operation:

- Compressor running
- Drum rotating
- Fans running
- Buttons and zippers on the garments
- Pump running and condensate pumping to condensation tank

Safety and warnings



This dryer contains flammable and explosive coolant.

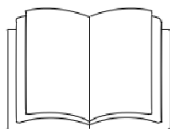

Absolutely read these instructions for use.

The dryer complies with current European safety standards. In any case, improper use can cause damage to people and/or things. Before operating the appliance, carefully read these instructions for use. It includes important instructions for the safety, use and maintenance of the appliance. In this way, danger to user and damage to the appliance is avoided. Pursuant to the IEC 60335-1 standard, the manufacturer expressly warns that it is absolutely necessary to read and follow the information contained in the chapter for the installation and maintenance of the dryer

as well as the safety instructions and warnings.

The manufacturer is not liable for damage resulting from non-compliance with these warnings. Read and follow the instructions for commissioning and installation as well as all other information provided with this appliance. Keep this instruction booklet carefully and also deliver it to any future users.

Intended use

Use the appliance for domestic use and only for drying and freshening household laundry. In particular, of garments washed with water that are suitable for drying with a centrifuge (see label on the garment).

Any other use can be dangerous. The manufacturer is not liable for dam-

age caused by improper and/or incorrect use of the appliance.

Do not install or operate this appliance in areas at risk of freezing and/or outdoors. In this case, there is a risk that the appliance will be damaged if the water left inside freezes. If the tubes freeze, they may crack/burst. This device is designed to be used at a maximum height of 4000 meters above sea level.

In other cases of use, the dryer must not exceed the domestic use. Some examples are:

- kitchen areas for staff in shops, offices and other work environments;
- farms;
- by customers in hotels, motels and in other residential environments;
- environments like bed and breakfast;
- areas for collective use

in condominiums.

Use by children or very vulnerable people

The appliance can be used by children under the age of 8 and by people with reduced physical, sensory or mental abilities or without experience or the necessary knowledge, as long as they are under surveillance or after they have received instructions relating to the safe use of the appliance and an understanding of the dangers inherent to it. Children must not play with the appliance. Cleaning and maintenance must not be carried out by children unsupervised. Children under the age of 3 must be supervised when the appliance is in operation.

Definitions of children

Very young children

Up to 3 years of age.

Children

Ages between 3 and 8 years.

Older children

Age between 8 and 14 years.

Vulnerable people

Persons with reduced physical, sensory or mental abilities (e.g. partially disabled, adults with reduced physical and mental abilities), or without experience and knowledge (e.g. older children).

Technical safety

Before installing the dryer, make sure that there is no visible damage. Do not install or operate the dryer if it is damaged. Before connecting the tumble dryer to the mains, make sure that the connection values (protection, voltage and frequency) shown on the

data plate correspond to those of the mains. If in doubt, consult a qualified electrician. Safe and reliable operation of the dryer is guaranteed only if the machine is connected to the public electricity network.

The electrical safety of the dryer is guaranteed only if the machine is connected to an electrical system in accordance with the law, equipped with a special differential magneto-thermic switch (lifesaver) and earth cable.

It is important to ensure that this condition is verified, as it is essential for safety. If in doubt, have the system checked by a specialized technician. Do not use extension either cords or adapters.

N.B:

The manufacturer is not

liable for any damage caused by the absence or interruption of the protective conductor.

If the power supply cable is damaged, it must be completely replaced by a qualified technical personnel authorized by the manufacturer to avoid any danger to the user.

Repairs not performed by certified technicians can expose the user to serious dangers, for which the manufacturer assumes no responsibility.

Any repairs must be carried out by the manufacturer's authorized technical assistance service; otherwise the manufacturer is not responsible for any damage that may result and the warranty is void. Replace broken or defective parts with original spare parts; only in this way can the manufacturer guarantee full

compliance with the quality and safety standards set for his machine.

In case of breakdowns or for cleaning and/or maintenance operations, keep in mind that the dryer is disconnected from the power supply only if:

- The power cord plug is not inserted into the socket.
- The main switch of the home electrical system is off.

Do not install the appliance in non-stationary places (e.g. on ships).

No changes can be made to the dryer that have not been expressly authorized by the manufacturer. The drying technology used is a heat pump with gas refrigerant R290. This dryer is equipped with a lamp that illuminates the inside. It is not suitable for lighting the environment. The

replacement can only be carried out by personnel authorized by the manufacturer or by the manufacturer's authorized technical assistance.

After positioning the appliance, wait an hour before starting a drying programme. It is possible to cause damage to the machine by damaging the heat pump operating it too early.



Refrigerant

The R290 refrigerant contained in this dryer is flammable and explosive. If the dryer is damaged, follow the measures:

- Avoid a naked flames or sources of ignition.
- Disconnect the dryer from the power supply.
- Ventilate the place where the dryer is positioned.
- Notify the manufacturer's technical assistance service centre.

Always ensure the accessibility of the socket in order to disconnect the dryer from the mains at any time. Do not cover or reduce the space between the bottom of the dryer and the floor, for example with plinths, strips, long-pile rugs, etc. Otherwise sufficient ventilation is not guaranteed. In the door opening area, there must be no lockable doors, sliding doors or doors with hinging opposite to that of the door of the appliance.

Correct use

Do not exceed maximum nominal load, which may vary according to the model, (dry laundry), depending on the nominal capacity. Partial loads for individual programmes are shown in the "Programme list" chapter.



Fire danger

Do not operate the

dryer if connected to a manoeuvrable multiple socket (eg via programmer timer or electrical system with maximum peak load disconnection device). If the drying programme is interrupted before end the cooling phase, there could be the danger of the laundry being selfignited.

Never switch off the dryer before the programme finishes unless all the contents of the basket are removed immediately and spread out so that it can release all the heat.

If you use fabric softeners or similar products, follow the instructions on the packaging. Remove all objects contained in the pockets, e.g. lighters and matches. After each drying cycle, clean the fluff filters. Avoid using water to clean the filters. If the filters remain wet they can cause

malfunctions. As there is a risk of fire, garments cannot be dried if they are not clean enough or should have any residues. This is especially true for garments that:

- Have not been washed.
- They are not sufficiently cleaned; they contain oil or grease or other residues (for example kitchen linen or beauticians' salons with residues of oils, greases or creams). For garments that are not sufficiently cleaned, there is a risk of fire due to self-combustion. Even at the end of the drying process and outside the appliance.
- Have been treated with flammable products or have stains from these products such as acetone, alcohol, gasoline, petroleum, kero-

sene, stain removers, turpentine, wax, substances that remove wax or other chemicals (e.g. on rags, tea towels, mops).

- Have residues of sprays, hair sprays, acetone or similar products.
- Garments on which industrial chemicals have been used for washing (for example dry cleaning).
- Laundry containing parts in rubber, foam rubber or similar. These can be latex items, shower caps, waterproof fabrics, rubber items, clothing or items with rubber parts, cushions with foam pieces of padding.
- Padded and damaged garments (e.g. cushions or jackets). The protruding padding material could cause a

fire.

- Do not introduce water dripping laundry.

This dryer develops heat in the casing during operation with its heat pump.

It is therefore necessary to ensure:

- Constant ventilation during the entire drying process.
- An air gap between the floor and the underside of the dryer that must not be obstructed or reduced in size.

Do not spray water on the dryer. Do not lean on or make a leverage on the door, otherwise the dryer could overturn.

The heating phase is followed in many programmes by the cooling phase so that the garments/objects are kept at a temperature that does not damage them (to reduce the risk of self-ignition). Only after this

phase can the programme be considered concluded. Remove all the laundry as soon as the programme has finished.

Close the door at the end of each drying cycle. This prevents:

- Children try to get into the dryer or hide objects in it.
- Animals can slip into it.

Do not operate the dryer without:

- Fluff filters or with damaged fluff filters.
- Without the heat exchanger cover (door).

The dryer would be clogged with consequent damage and malfunctions.

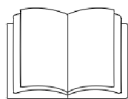

Condensation

Do not install the dryer in areas exposed to temperature lower than 5°C or above 35°C. If the condensed water freezes in the pump and

in the drain pipe, it can cause serious damage to the machine. If you drain the condensation water outside, for example in a sink, fix the drain hose so that it does not slip. Otherwise it could spill causing damage. Condensation water is not drinkable. If ingested it is toxic to both humans and animals.

Always keep the environment where the dryer is installed clean from dust and impurities. Dust and impurities present are sucked in together with the air and will eventually clog the heat exchanger.

INSTALLATION

Transportation

Transportation of the dryer can be carried out as shown in the illustration below.

Figure 1

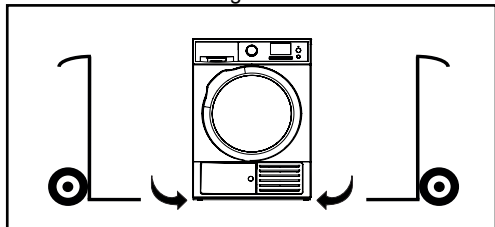

For transportation, use a trolley positioned only on the right or left side of the wall.



Attention!

Incorrect handling of the dryer can cause damage to things and people.

Pay attention during the handling phase and in case of overturning wait an hour before switching on to avoid damage to the heat pump.

Figure 2

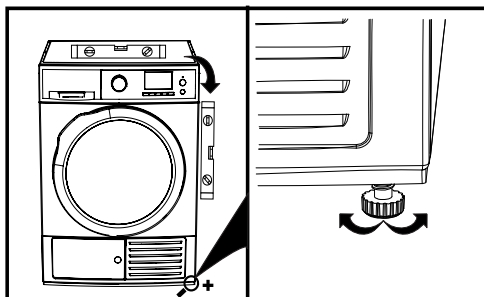

Attention!

Before normal use of the appliance, clean the drum with a damp cloth in order to eliminate any traces of lubricants used in the production process.

Aeration

The drying process causes the dryer to heat up with simultaneous heating of the external environment. For this reason it is advisable to always ventilate the room.

Positioning

Before installing the appliance, carefully read the instructions in the **Safety and Warnings** chapter

For maximum performance, it is advisable to position the dryer in a perfect level with levelling instrument and compensate for any irregularities on floor surface with the adjustable feet.



ATTENTION!

Do not cover the openings for the cooling air in front when the dryer is running.

Do not cover or reduce the space between the floor and the base of the dryer (pedestals, strips, rugs).

Place the appliance in vertical position and wait 12 hours before starting.

Drainage of condensation

The water condensation that forms during the drying process is conveyed into a drawer that must be emptied manually.

Figura 3

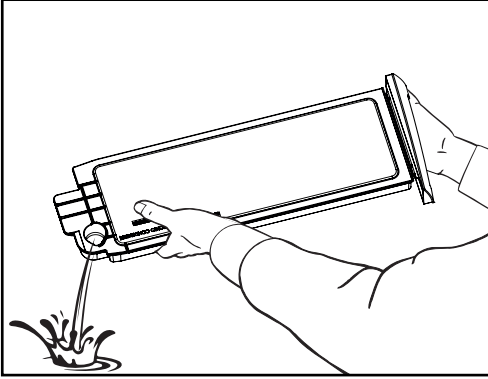

It is possible to convey the condensation water to the domestic drainage pipe by connecting it in one of the different ways.

Connect the drainage hose (figure 4a) in one of the following ways (figure 4b):

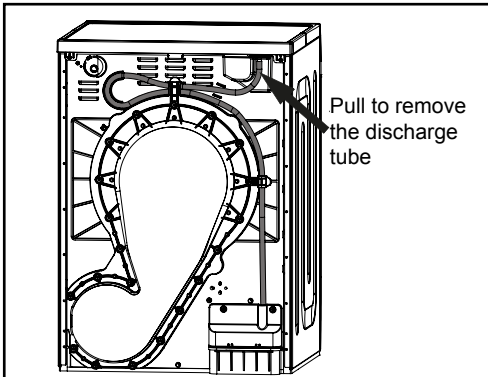

1. **On the edge of a sink.**
2. **In a drainage pipe located at a height of not less than 60cm and not more than 90cm.**
3. **Direct drain into the sink siphon.**

Figure 4b

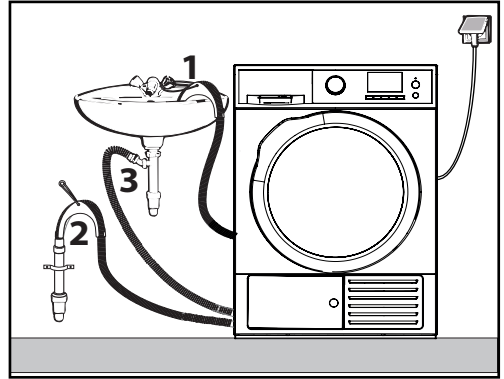

The dryer can be installed under the furniture without removing the top cover. It is important to leave ventilation space around it. The drying duration may increase in case of insufficient ventilation.

Electrical connection

The appliance is equipped with a power cable with schuko (EU) plug for connection to the AC power supply ~ **230 V 50 Hz**. Make sure that the schuko (EU) plug is always accessible in order to disconnect the appliance from the mains. The electrical system must be made according to VDE 0100 standards. The maximum absorption of the appliance is **10 amperes**.

It is recommended never connect the machine with extension cords, multiple sockets or similar to avoid overheating and therefore a potential fire hazard. The manufacturer declines all responsibility for damage due to the lack or interruption of the protective conductor. To increase safety, the VDE institute, in the DIN VDE 0100 part 739 directive, recommends providing the machine an automatic differential switch (lifesaving) with tripping current 30mA (DIN VDE 0664). If an RCD is used, check that it is type A, compliant with DIN VDE 0664 and sensitive to pulsating currents. The data plate provides information on the nominal absorption and relative protection. Compare these data with those of the electrical network.

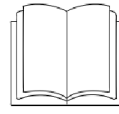

Attention!

This dryer requires the grounding.

For personal safety, and the goods that surround the dryer, it must be connected to an electrical system that is equipped with an earthing conductor appropriately checked in accordance with the law and a differential magnetothermic switch (life-saving). This dryer is equipped with a power cord (A) and a plug (B).

To avoid the risk of electric shock/fire, the cord must be plugged into a wall socket (C) suitable for the type of plug. (B)

Do not modify the power cable and do not use adapters or extensions (D)

If the wall socket is not available, it is the customer's personal responsibility and obligation to have one installed by a qualified electrician.

The appliance must not be supplied through an external switching device, such as a timer, or connected to a circuit that is regularly switched on and off by a utility.

Figure 5

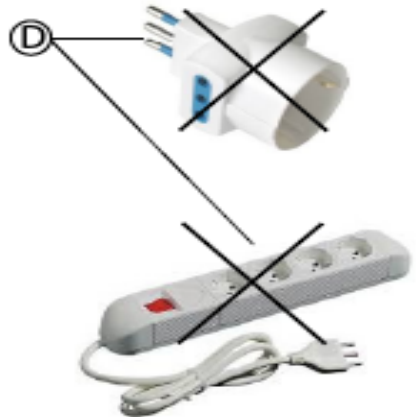
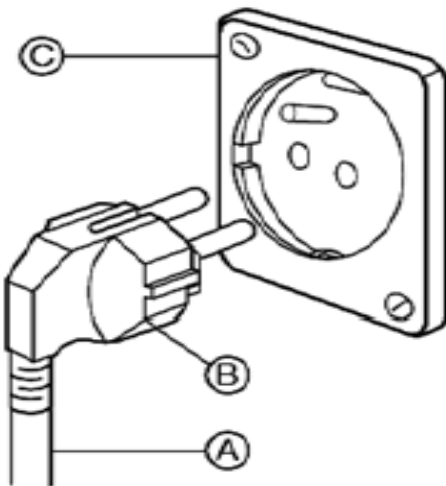

Main features

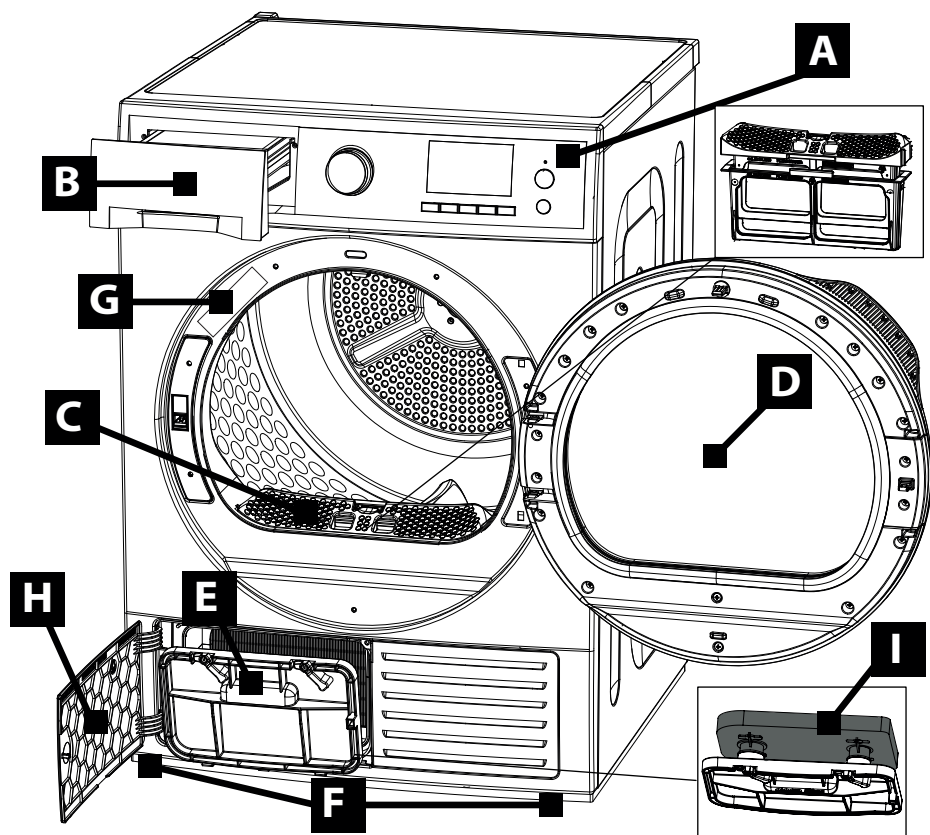

- | | | |
|----------------------------|-------------------------------|--------------------------------|
| A Control panel | E Heat exchanger cover | I Heat exchanger filter |
| B Condensation tank | F Adjustable feet | |
| C Filtri fluff | G Data label | |
| D Door | H Heat exchanger door | |

Before use

Before using the product for the first time, the appliance drum must be:







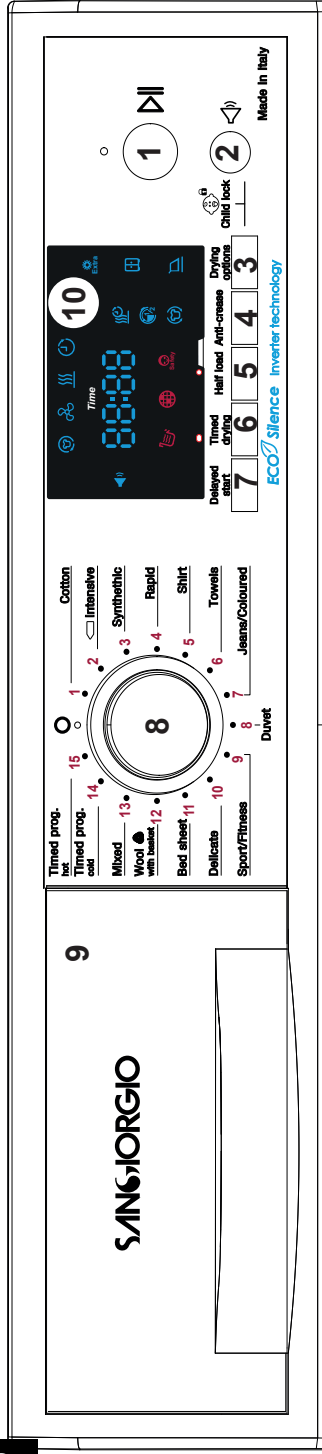





- cleaned with a damp cloth.

The initial phase (3 - 5 minutes) of the drying cycle may be slightly noisier. This is due to the start of the compressor.





This is not a manufacturing defect, but it is the normal operation of all equipment fitted with compressors (e.g. refrigerators and freezers).











- 1 - Start/Stop key
- 2 - Buzzer button
- 3 - Drying options selection button
- 4 - Reverse agitation selection key
- 5 - Half load selection key
- 6 - Timed drying selection key
- 7 - Delayed start selection key
- 8 - On/Off and programme selection knob
- 9 - Condensation tank



















-  Condensation tank full alarm
-  Clogged heat exchanger alarm
-  Child safety alarm
-  Dry iron-ready
-  Wardrobe
-  Extra drying
-  Reverse agitation icon
-  Half load drying icon
-  Timed drying icon
-  Anti-crease icon
-  Cooling phase icon
-  Drying phase icon
-  Delayed start icon

International drying symbols

| Suitable for drying | | | Not suitable |
|---|---|---|---|
|  |  |  |  |

DRYER PROGRAMMES

| No | Programme | Description | Nominal capacity | | Symbols |
|----|--------------------|--|------------------|--------|--|
| | | | SDR8 | SDR9 | |
| 1 | Cotton | The programme dries cotton laundry for ironing, so that it is slightly damp to make ironing easier. | 8 kg | 9 kg |  |
| 2 | Intensive | From the point of view of energy consumption, this programme is the most efficient for drying normally wet cotton laundry. This programme is the TEST programme according to 392/2012/ EU regulation for the energy labelling with values measured according to EN 61121 standard. | 8 kg | 9 kg |  |
| 3 | Synthetic | The program dries all synthetic laundries ready to be placed in the wardrobe, without ironing. | 4 kg | 5 kg |  |
| 4 | Rapid | The programme is used to dry cotton laundry spun at high speed in the washing machine. | 2 kg | 2,5 kg |  |
| 5 | Shirts | The programme is suitable for all resistant shirts and blouses, suitable in cotton programme. | 2,5 kg | 2,5 kg |  |
| 6 | Towels | The programme is used for cotton or linen fabrics, tablecloths, sheets, starched or damp linen that must be treated after drying. | 6 kg | 7 kg |  |
| 7 | Jeans/ Coloured | All garments in jeans, such as jackets, trousers, shirts, jackets and coloured garments. | 4 kg | 3 kg |  |
| 8 | Duvet | This programme is used for duvets. | 2,5 kg | 2,5 kg |  |
| 9 | Sport/ Fitness | This programme is used for quick drying. It must be used with a delicate basket. | 2 kg | 2,5 kg |  |

| No | Programme | Description | Nominal capacity | | Symbols |
|----|------------------|--|------------------|--------|--|
| | | | SDR8 | SDR9 | |
| 10 | Delicate | This programme dries delicate cloths or laundry with the hand wash symbol. | 2 kg | 2.5 kg |    |
| 11 | Curtain | This programme is ideal for all types of curtains. | 2,5 kg | 3 kg |    |
| 12 | Wool with basket | This programme is for wool or wool blends, soft washable toys, pullovers, wool jackets and socks. It is necessary to use the delicates basket. | 3 kg | 3,5 kg |    |
| 13 | Mixed | This programme is used for mixed loads of laundry made of cotton and synthetic. | 4 kg | 4,5 kg |    |
| 14 | Timed prog. cold | This is a laundry refreshment programme. By blowing in air at room temperature, this programme refreshes the laundry that has been closed for a long time to eliminate bad odours. | 3 kg | 4 kg |    |
| 15 | Timed prog. hot | The programme allows to reach a desired level of drying at low temperature based on the setting time, regardless of the degree of dryness. The time can be set up to 3 hours. | 8 kg | 9 kg |    |

Drying option table

| Nome | Easy iron | Wardrobe | Extra dry | Anti-crease | Half load |
|-----------------------|-----------|----------|-----------|-------------|-----------|
| Cotton | X/O | X | X | X | - |
| Intensive | X | X/O | - | X | X |
| Synthetic | - | - | - | X | X |
| Rapid | X/O | X | X | X | - |
| Shirt | X/O | X | X | X | X |
| Towels | - | X/O | X | X | X |
| Jeans/ Coloured | X | X/O | X | X | - |
| Duvet | X | X/O | X | X | - |
| Sport/Fitness | X | X/O | - | X | X |
| Delicate | X/O | X | - | X | - |
| Bed sheet | X/O | X | X | X | - |
| Wool with basket | X/O | X | X | X | X |
| Mixed | X/O | X | X | X | X |
| Timed programme: Cold | - | - | - | X | - |
| Timed programme: Hot | - | - | - | X | - |

Legend

- X Activatable
- Non activatable
- O Default



Dryer functions description

1. Start/pause button

The button allows for the start of a drying programme, after correct turning on (see point 8). The start or pause occurs by pressing the key.

2. Buzzer button

The dryer is supplied with a multi-melody buzzer. The buzzer melody is associated with the fault status, the programme selection, alarms and the end of drying programme.

The buzzer is active by default. It can be activated or deactivated by pressing the key . The activation or deactivation status indicated by the LED  illuminated. It is turned on if activated or turned off if deactivated.

If an option is not selectable due to its incompatibility with a specific programme, the incompatibility noise is emitted with a quick flash of the icon. If an error appeared during the drying process and it is not possible to continue the cycle, the display shows the error code accompanied by the buzzer sound.



3. Drying options selection button

The button allows for the selection of a drying level. Only one drying level can be selected at a time. The selection of the drying level is made with the button . Selectable states are indicated by corresponding

icons  ,  e  Extra .

One press on the key  will activate the next drying level by illuminating the icon.

4. Reverse agitation selection button

The reverse agitation option can be added to the standard programme, which changes the direction of rotation of the drum. It aims at reducing the formation of crease. It is activated by pressing button  which will illuminate the corresponding icon  on the display.

It is recommended for larger or longer garments. The option is performed at the end of the drying cycle.



5. Half load selection button

Button  activates and deactivates the half load function. The half load option is used to reduce the drying time.



Activation and deactivation lights up and turns off the corresponding icon  on the display.

6. Timed drying selection button

Timed drying programmes are programmes in which you can decide the exact duration of the drying programme. The duration selection range is from 20 minutes to 3 hours.

Each time the button  is pressed, there will be an increase of 10 minutes to the corresponding last duration shown on the display .

7. Delayed start



The delayed start function is used to allow delay the start of the drying cycle. It is activated by the key marked . The user can select the delayed time at a resolution of one hour. The possible values are from 0 to 24 hours of delay. This time is shown on the display .

If the button or other are not pressed for about 5 seconds, the display  will show “program duration + delayed time” as the remaining time to complete drying.

8. Power on

The dryer is switched on by rotating the knob located at the centre of the control panel. Its rotation allows you to switch on and select a drying programme without starting the programme.

9. Condensation tank

The condensation water that forms in course of drying and is collected in a condensation tank . When it is filled to the maximum level of the container, the indicator light  turns on. To cancel it, the container must be emptied.

Remove the condensation tank by extracting it with both hands.

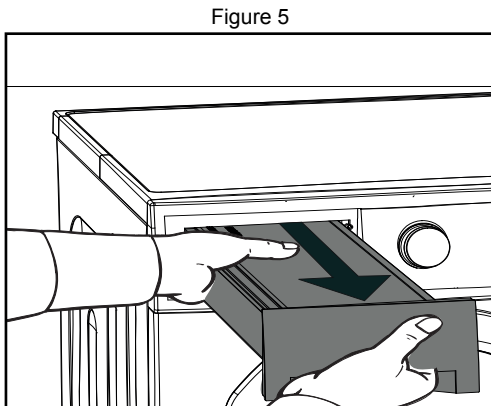

Transport the tank holding it horizontally so as not to spill the water by holding it both at handle and at the other end.

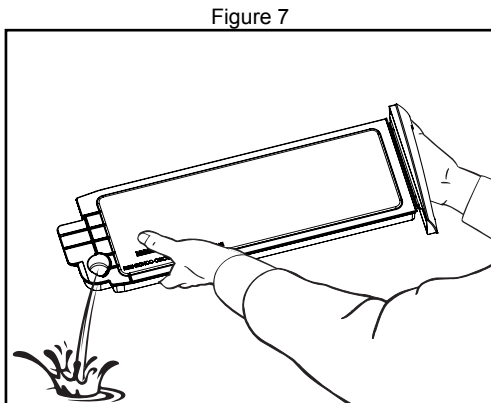

Empty the tank and put it back in the dryer.

Condensation water can be used (eg with irons with steam boilers or air humidifiers).

As a precaution, before using the condensed water, filter it with a fine sieve or a coffee paper filter to remove all the fluff in order to avoid damaging the equipment.



WARNING!

Condensed water is harmful to both people and animals. Do not drink the condensed water.

Preparation of the laundry

Before starting a drying programme, make sure that:

- The garments are divided according to the type of fabric and size, respecting the drying symbols shown on the label of the garments.
- Tie bandages and laces all together.
- Pillow covers and bedspreads should be buttoned up to prevent other items from getting inside.
- Hooks and buttons are closed.
- Remove or sew bras with underwire.
- Use the grid provided for wool, sneakers, bedspreads and soft toys
- Small items, such as socks, underwears, etc. can be positioned themselves on the fluff filter obstructing the flow of air. It is recommended to use a special bag.

Drying

Consult the table of programmes on page 18 for the type of load capacity and fabric. In either conditions be sure that:

- The maximum load of each programme is respected.
- Laundry with goose down feather, if not suitable for drying in tumble dryer, could shrink.
- Pure linen fabrics can be dried only if it is explicitly indicated within laundry garment label symbols. Otherwise the fabric will roughen.
- Wool and wool blend garments tend to shrink. Use only the dedicated programme and the basket supplied.
- Sweaters tend to shrink in the first wash, so do not over dry



Attention!

Check for foreign bodies, which could melt, burn or explode.



Attention!

Always check the drying symbols on garments. See table on page 18

Figure 13

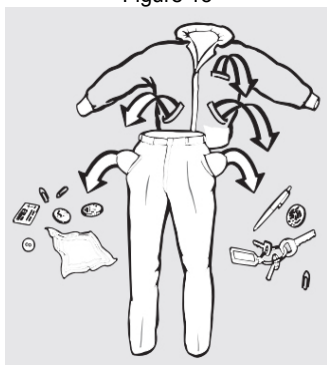

Starting a programme

Selecting and starting a drying programme

Via the programme knob (8), a drying programme can be selected or machine can be switch off. The knob turns in both directions which facilitates quick selection or shut-down of the dryer.

After selecting a programme, further settings can be made.

Not all programmes allow further setting.

To start a drying programme, press the button (1) start/pause.

Change programme during drying process, add or remove laundry

It will no longer be possible to change the programme in progress if it is not switched off by placing the programme knob in the OFF position for a few seconds.

To be able to select a new programme, the one in progress must first be interrupted.

To add or remove the laundry, the door can be opened.

All programme settings remain stored. If it is necessary to change it again, place the programme knob on OFF for seconds to delete the previous one.



Keep in mind that after opening the door, very hot water vapour can escape.

Do not touch the posterior part of the drum when adding or removing laundry. At the rear, the temperatures are particularly high.

At the end or at the shut-down of the programme, before removing the laundry, ensure that the laundry has cooled down.

If you press the start/pause button (8) again at the same time the drying programme will restart.

Ending programme

Open the door only when the drying process is finished. Otherwise, the laundry not satisfactorily dry and cool down to an acceptable temperature.

To open the door, insert your fingers into the hollow of the handle and pull. Remove the laundry.

Laundry forgotten in the machine could be damaged due to prolonged drying. Therefore, always remove all the laundry from the drum.

Delicate basket

The dryer is supplied with a distending basket with rack for drying delicate items (wool, stuffed animals, sneakers, etc.).

To start drying with the basket, it has to be hooked the two feet in the seat of the

fluff filter. Use the delicate basket only with timed drying programs or with programs where it is clearly specified.

Figure 8

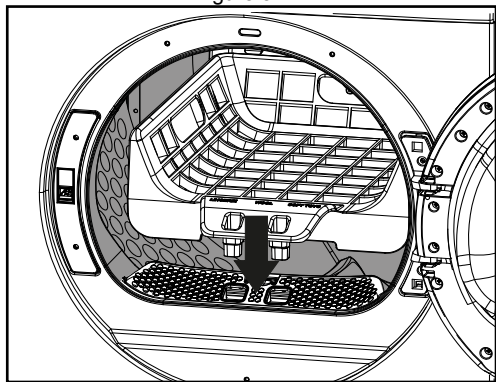

To dry delicate laundry, place the basket over the rack and place the laundry as illustrated below.

Sneakers and teddy bears must be placed in the rack without a basket.

To facilitate the drying process of shoes, pull out the flap of the shoes and remove any insoles or heel pads. Place an inclination (of rolled towel) in order to obtain an inclined surface.

Figure 9

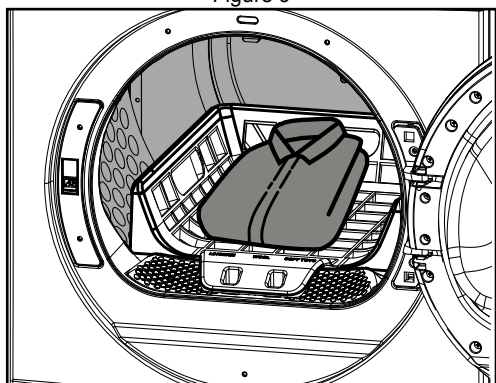

Attention!

Do not use the basket for delicates if it is damaged. It can cause damage to clothing and the dryer.

Energy saving

The dryer with heat pump technology is designed to dry with significant energy savings. A further energy saving can be obtained following indications given, which allow to reduce the drying time.

Spinning the laundry in the washing machine at the maximum recommended speed. For example, if the spinning is at 1400rpm instead of 1000rpm, about 20% of the electricity will be saved, in addition to the drying time.

- Use the maximum load in the respective drying programmes. In this case, the electricity consumption, compared to a full load, will be minimized.
- After each drying cycle, clean the lint filters under the door.

Technical data

| Description | Values | |
|-----------------------------|--------------------|--------------------|
| | SDR8 | SDR9 |
| Height x Width x Depth | 850 x 596 x 636 mm | 850 x 596 x 636 mm |
| Depth with door open | 1054 mm | 1054 mm |
| Furniture height | 870 mm | 870 mm |
| Furniture width | 650 mm | 650 mm |
| Furniture depth | 650 mm | 650 mm |
| In-built installation | Yes | Yes |
| Weight | 60 kg | 62 kg |
| Drum volume | 108 lt | 116 lt |
| Nominal capacity | 8,0 kg* | 9,0 kg* |
| Volume of condensation tank | 4,5 l | 4,5 l |
| Length of tube | 1,40 m | 1,40 m |
| Maximum drainage height | 0.9 m | 0.9 m |
| Current | 230V | 230V |
| Frequency | 50Hz | 50Hz |
| Safety check markings | Check rating label | |
| LED light emitting diodes | Class 1 | Class 1 |
| Type of gas | R290 | R290 |
| Power | 800 W | 800 W |
| Current | 10 A | 10 A |
| Ambient temperature | 5° - 35° | 5° - 35° |

EC energy data 392/2012

The information shown in the table below is in compliance with the European Commission directive 392/2012 which implements directive 2009/125

| | | |
|---|-----------|------|
| Model identification | SDR8 | SDR9 |
| Type of dryer | Heat pump | |
| Energy efficiency class | A++ | A+++ |
| Energy consumption in kWh/year * | 236,80 | 258 |
| Automatic or non-automatic tumble dryer | Automatic | |
| Energy consumption of standard drying programme at full load for cotton fabrics in kWh | 1.67 | 1.95 |
| Energy consumption of standard drying programme at partial load for cotton fabrics in kWh | 1.00 | 1.08 |
| Weighted power consumption in off-mode in W | 0.16 | 0.19 |
| Power consumption in left-on mode stable in W. | 0.19 | 0.19 |
| Power consumption in left-on mode stable in W. | 0.24 | 0.24 |
| Duration of left-on mode in minutes | 5 | 5 |
| Weighted duration of the standard drying programme ** at full load and at partial load expressed in minutes | 135 | 154 |
| Weighted duration of the drying standard programme ** at full load expressed in minutes | 172 | 200 |
| Weighted duration of the standard drying programme ** at partial load expressed in minutes | 108 | 120 |
| Condensation efficiency class *** | A | A |
| Average condensation efficiency of the standard drying programme at full load expressed as a percentage | 89 | 92 |
| Average condensation efficiency of the standard drying programme at part load expressed as a percentage | 92.3 | 89.9 |
| Average condensation efficiency of the standard drying programme at full load and at partial load expressed as a percentage | 91 | 91 |
| Noise level in dB(A) | 64.8 | 64.8 |
| In-built appliance (Yes/No) | No | |

** Energy consumption in kWh/year, based on 160 drying cycles of the standard drying programme for cotton fabrics at full and partial load. Actual consumption per cycle depends on how the appliance is used.

** The "standard drying programme" is the standard drying programme to which the labelling and product sheet refers. It indicates the most efficient programme in terms of energy consumption for drying cotton laundry.

*** Condensing efficiency class on a scale from G (minimum efficiency) to A (maximum efficiency)

Maintenance

Filter cleaning

This tumble dryer is equipped with two fluff filters: one inside (I) and one outside (E). Clean both filters after each drying. This prevents an extension of the programme duration.

The icon  on after a specific number of drying cycles for a cleaning the filters.

Figure 14

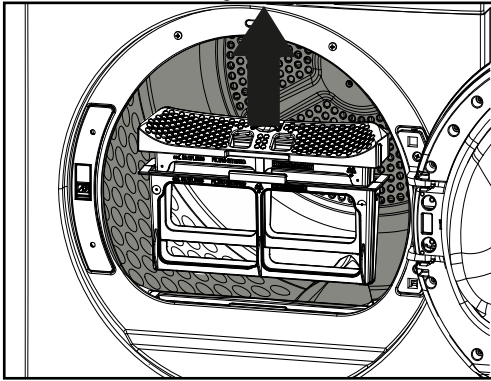
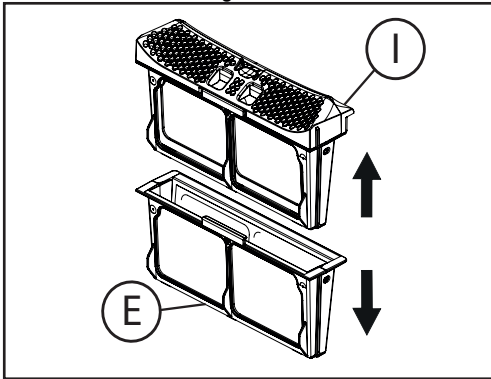

Figure 16



Open the mesh filters and clean by removing all fluff residues. Avoid using water to clean the filters, being careful not to leave residues inside the dryer.

Cleaning heat exchanger inlet

The heat exchanger is located at the bottom left of the front of the dryer. To open the door, turn the levers anticlockwise.

Figure 18

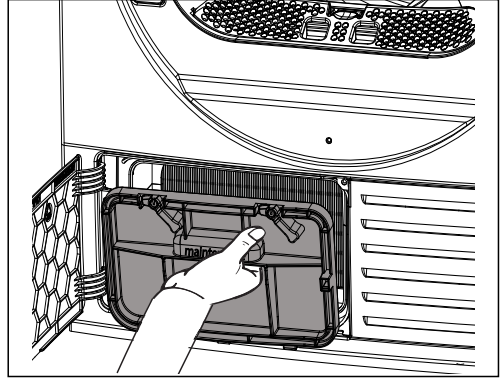

Gently, remove the fluff residue between the fins of the heat exchanger (Figure 19). If it is dirty, clean it with a brush or vacuum cleaner. Do not apply much pressure so as not to damage the slats.

Figure 19a

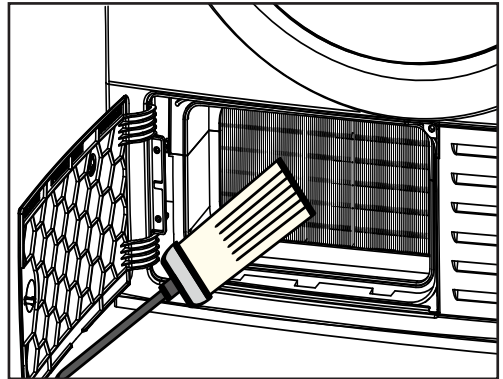

Once the cleaning operations have been completed, re-insert everything into its seat making sure that the exchanger cover is correctly inserted in its housing.

Figure 19a

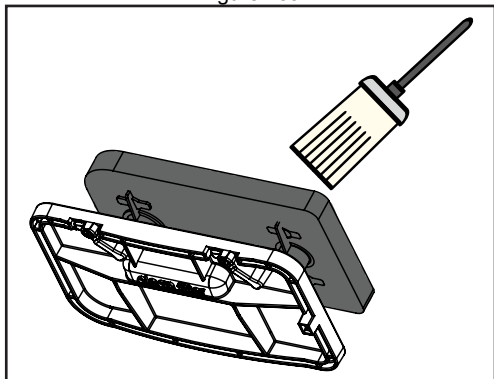

Once the cleaning operations have been completed, reinsert everything in its seat, making sure that the heat exchanger door is correctly inserted into its housing.



Attention!

Proceed with the cleaning operations in a delicate manner so as not to compromise the proper functioning of the dryer.

The cooling fins can be sharp, do not touch them directly.

Gently remove the fluff residue from the condenser filter.

Gasket and closing edge cleaning

Clean the gasket on the inside of the door and the closing edge using a damp cloth and a solution of water and soap.

Figure 20

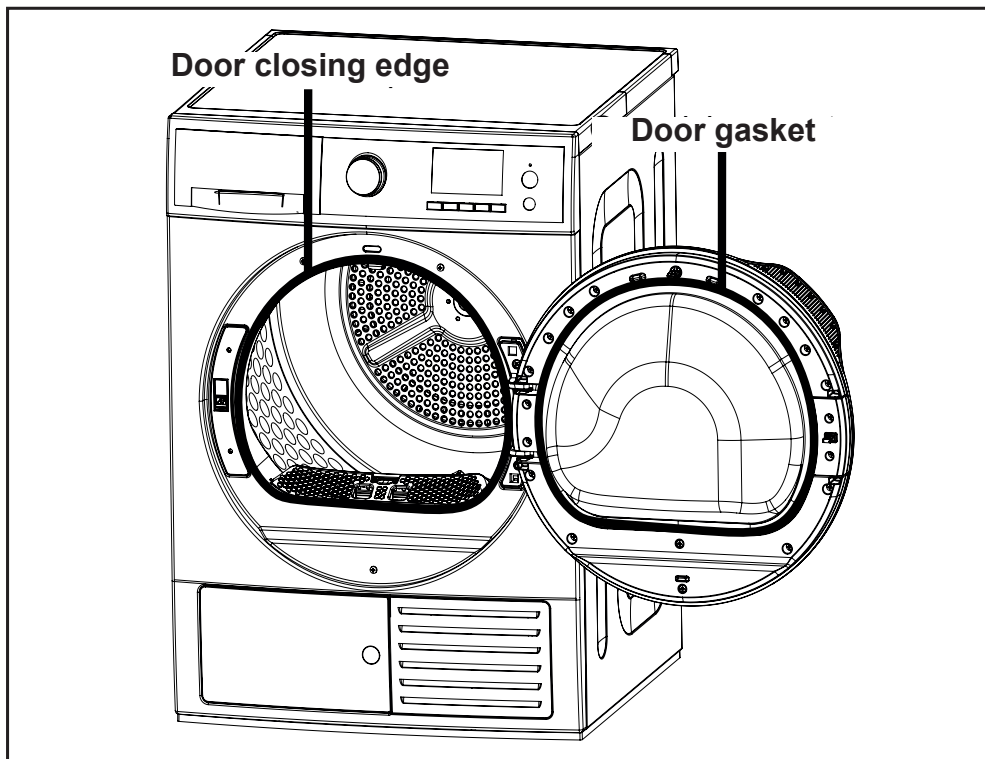

Cleaning humidity sensors

Clean the humidity sensors inside the drum with a soft cloth. The use of fabric softeners will tend to create an oily film that affects its operation.

Figure 21

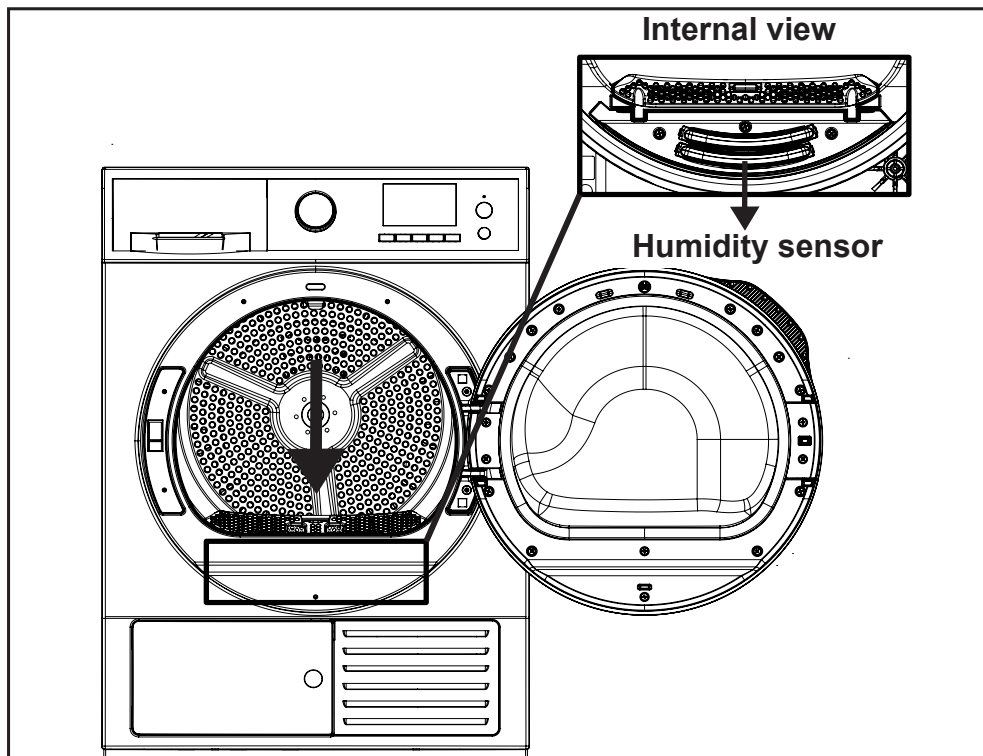

Attention!

Too aggressive cleaning products can damage plastic surfaces and other components.

Do not use detergents, abrasives, glass cleaners or universal cleaners.

What to do in case of ...

Most of the anomalies that occur in daily use can be resolved independently. In many cases it is possible to save time and costs without necessarily having to contact authorized technical assistance. The following table helps to identify and possibly eliminate the anomalies, otherwise contact the assistance.

| <i>Error codes</i> | <i>Solutions</i> |
|---------------------------|--|
| F1 | If the error appears during use, turn off and try again. If the error persists, contact qualified technical service centre. |
| F2 | Turn off the dryer and check that the front, rear and bottom ventilation channels are not blocked. After checking, try again and if the error persists, contact qualified technical service centre. |
| F3 | Turn off the dryer and make sure that the fluff and impurity filters are not clogged. After checking, start again the appliance and if the error persists, contact qualified technical service centre. |
| F4 | Turn off the dryer and make sure the drain hose is not blocked or squashed. Make sure that the condensation tank is not full. After checking, try again and if the error persists, contact qualified technical service centre. |
| F5 | If the error appears during usage, turn off and try again. If the error persists, contact qualified technical service centre. |
| F6 | Make sure the door is correctly closed door and make sure that the nib present in the upper part is proper in its sit. After checking, try again and if the error persists, contact qualified technical service centre. |
| F7 | If the error appears during usage, turn off and try again. If the error persists, contact qualified technical service centre. |
| F8 | If the error appears during usage, turn off and try again. Make sure there is no metal object or damp cloth stuck on the humidity sensors. If the error persists, contact qualified technical service centre. |

After-sales assistance guidelines

All appliances are covered by a conventional warranty period (24 months). At the time of the home visit of an authorized technician, the proof of purchase showing the date of purchase of the appliance and the model must be made available. If no proof of purchase is presented, the cost of the exit/labour and spare parts will be borne by the consumer.

Technical assistance intervention timing

1. For interventions to be carried out on non-running, non functional appliances: the intervention is guaranteed within 4/6 working days;
2. For interventions/checks to be carried out on running appliances: the intervention/check is guaranteed within 8/10 working days.

Defect evaluation

1. If the defect is attributable to a manufacturing defect, no cost will be incurred throughout the period of the guarantee which starts from the date of purchase of the appliance.

Examples of manufacturing defects

Given that the appliance is connected to an electrical system in accordance with the law;

- the appliance does not turn on;
- it does not run drying programmes;
- the drum does not turn;
- the appliance does not dry.

2. All problems deriving from neglect and/or external causes do not fall within the scope of manufacturing defects.

In these cases, the costs of the intervention and any spare parts are the sole responsibility of the consumer (for intervention out of warranty - see point 4 of the Warranty Certificate at the end of the manual).

Examples of problems due to neglect or external causes or wrong impression are:

- Incorrect, imperfect or incomplete installation (use of adapters and/or extensions, modification of electric cable, absence of grounding);
- Appliance placed on pedestals, platforms, balconies, terraces, canopies in direct contact with atmospheric agents or in unventilated rooms;
- Failure to comply with the instructions for use and maintenance (clogged filter, feet not adjusted and/or in contact with wet surfaces, excessive load);
- All cases in which the complained/feared defect has not been found, due to a mistake impression of the end user (noise, vibration or hopping, does not dry well, tears the laundry ...).

After sales service

Repairs

Many problems can be solved independently by the user by using the information on the faults reported in these instructions.

If this is not possible, please contact our customer service centre. We always find an adequate solution and try to avoid unnecessary visits by service technicians.

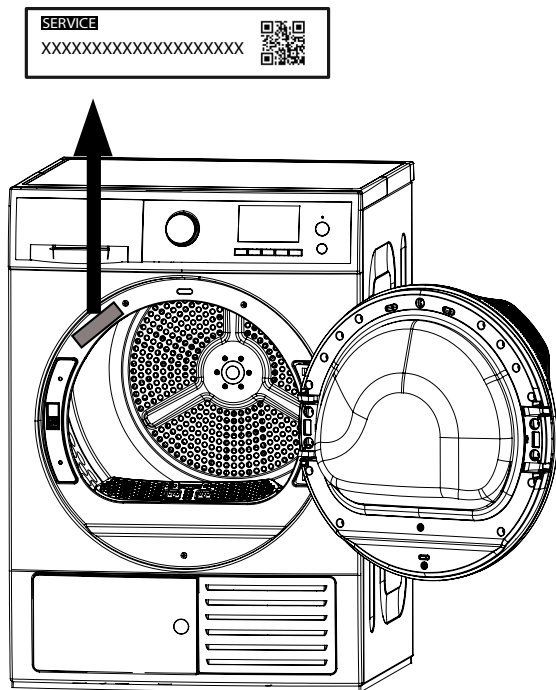

Ensure that the appliance is repaired only with original spare parts and by specially trained customer service personnel, both during the warranty coverage and upon expiry of the same. For safety reasons, only adequately specialized and trained personnel can carry out repairs on the appliance. The warranty is void in the event that interventions or repairs are carried out by persons not authorized by the producer or in the event that our appliances are equipped with non-original spare parts, supplementary parts and accessories due to which a defect arises.

The original spare parts relevant for operation according to the corresponding Ecodesign regulation are available from our customer service department for a period of at least 10 years starting from the date of emission of the appliance in the market within the European Economic.

For any repairs, contact the authorized technical assistance service centre by calling the number indicated below.

Always communicate the **model** and **serial code** of the appliance, shown on the marking plate visible in the upper part of the door compartment when it is opened and/or in the back of the dryer.

Due to the continuous technological evolution of the products, the contents of this manual may have variations without prior notice from the producer.